

# DataMan<sup>®</sup> Configuration Codes

2021 May 26

Revision: 6.1.10-SR1.4

# Legal Notices

The software described in this document is furnished under license, and may be used or copied only in accordance with the terms of such license and with the inclusion of the copyright notice shown on this page. Neither the software, this document, nor any copies thereof may be provided to, or otherwise made available to, anyone other than the licensee. Title to, and ownership of, this software remains with Cognex Corporation or its licensor. Cognex Corporation assumes no responsibility for the use or reliability of its software on equipment that is not supplied by Cognex Corporation. Cognex Corporation makes no warranties, either express or implied, regarding the described software, its merchantability, non-infringement or its fitness for any particular purpose.

The information in this document is subject to change without notice and should not be construed as a commitment by Cognex Corporation. Cognex Corporation is not responsible for any errors that may be present in either this document or the associated software.

Companies, names, and data used in examples herein are fictitious unless otherwise noted. No part of this document may be reproduced or transmitted in any form or by any means, electronic or mechanical, for any purpose, nor transferred to any other media or language without the written permission of Cognex Corporation.

Copyright © 2021. Cognex Corporation. All Rights Reserved.

Portions of the hardware and software provided by Cognex may be covered by one or more U.S. and foreign patents, as well as pending U.S. and foreign patents listed on the Cognex web site at: [cognex.com/patents](http://cognex.com/patents).

---

The following are registered trademarks of Cognex Corporation:

Cognex, 2DMAX, Advantage, AlignPlus, Assemblyplus, Check it with Checker, Checker, Cognex Vision for Industry, Cognex VSOC, CVL, DataMan, DisplayInspect, DVT, EasyBuilder, Hotbars, IDMax, In-Sight, Laser Killer, MVS-8000, OmniView, PatFind, PatFlex, PatInspect, PatMax, PatQuick, SensorView, SmartView, SmartAdvisor, SmartLearn, UltraLight, Vision Solutions, VisionPro, VisionView

The following are trademarks of Cognex Corporation:

The Cognex logo, 1DMax, 3D-Locate, 3DMax, BGAll, CheckPoint, Cognex VSoC, CVC-1000, FFD, iLearn, In-Sight (design insignia with cross-hairs), In-Sight 2000, InspectEdge, Inspection Designer, MVS, NotchMax, OCRMax, PatMax RedLine, ProofRead, SmartSync, ProfilePlus, SmartDisplay, SmartSystem, SMD4, VisiFlex, Xpand

Portions copyright © Microsoft Corporation. All rights reserved.

Portions copyright © MadCap Software, Inc. All rights reserved.

Other product and company trademarks identified herein are the trademarks of their respective owners.

# Table of Contents

|   |    |
|---|----|
| Legal Notices .....                     | 2  |
| Table of Contents .....                 | 3  |
| Configuration Codes .....               | 5  |
| Product Settings .....                  | 6  |
| Reset .....                             | 7  |
| Disable Buttons .....                   | 8  |
| Diagnostics .....                       | 9  |
| Setup .....                             | 10 |
| Light Aimer .....                       | 11 |
| Trigger Type .....                      | 12 |
| Custom Commands .....                   | 14 |
| Maximum Exposure .....                  | 15 |
| Symbology Settings .....                | 18 |
| 2D Symbology Settings .....             | 27 |
| QR Code Maximum Grid Size .....         | 29 |
| 1D Symbology Settings .....             | 31 |
| Training .....                          | 33 |
| Data Validation / Data Formatting ..... | 34 |
| Non-Printable Characters .....          | 36 |
| Wireless .....                          | 37 |
| Buffering .....                         | 38 |
| Power Management .....                  | 39 |
| Wake-up Message .....                   | 41 |
| PS/2 Keyboard Emulation Enable .....    | 42 |
| ASCII Keyboard Command Codes .....      | 43 |
| iOS Keyboard Configuration .....        | 55 |
| USB Connection .....                    | 56 |
| USB Mode .....                          | 60 |
| Communications .....                    | 62 |
| RS-232 Baud Rate .....                  | 66 |
| RS-232 Parity Settings .....            | 68 |
| RS-232 Databit Settings .....           | 70 |
| RS-232 Stopbit Settings .....           | 71 |

|   |           |
|---|-----------|
| <b>RS-232 Handshaking .....</b>                 | <b>72</b> |
| <b>RS-232 Routing .....</b>                     | <b>73</b> |
| <b>Network Settings .....</b>                   | <b>74</b> |
| <b>Decode Settings .....</b>                    | <b>75</b> |
| <b>Multi-Reader Sync .....</b>                  | <b>76</b> |
| <b>Keyboard Layout .....</b>                    | <b>77</b> |
| <b>Alt Key Combo Zero Padding .....</b>         | <b>83</b> |
| <b>USB Keyboard Inter-Character Delay .....</b> | <b>84</b> |
| <b>WebHMI Commands .....</b>                    | <b>85</b> |

# Configuration Codes

This manual provides a list of Configuration Codes which are special Data Matrix codes to configure your reader without the DataMan Setup Tool. Lights and 1 beep indicate that a Configuration Code was read. If the code is read but the command is not executed (e.g. because of the command not being valid for the type of reader used for reading the code), the reader gives 2 beeps.

You can read configuration codes without enabling the decoding of Data Matrix symbols. Make sure that you use Manual or Presentation trigger mode.



Adjust focus settings if you have trouble reading Configuration Codes.

**Note:** When applying polarized filter on the reader, it is recommended to read the codes from a printed material. It is possible that the reader with a polarized filter cannot read the code correctly from a screen.



**Note:** When using wireless handheld readers, the reader must be put on the base station for security reasons after reading a printed configuration code.

**Note:** The asterisk indicates the default value for all the consecutive or the indicated reader(s).

# Product Settings

| Codes  | Settings and Supported Devices   | Codes   |
|--|--|---|
|   | <p>Reboot Scanner</p> <p>DM50 • DM60 • DM70 • DM150 • DM260 • DM300 •<br/>DM360 • DM370 • DM470 • DM475V • DM503 •<br/>DM8000 • MX-1000 • MX-1502</p>  |   |
|  | <p>Reboot Base Station</p> <p>DM8000Base (IBASE) • DM8700Base</p>  |  |
|  | <p>Save Settings to Reader</p> <p>DM50 • DM60 • DM70 • DM150 • DM260 • DM300 •<br/>DM360 • DM370 • DM470 • DM503 • DM8000 • MX-<br/>1000 • MX-1502</p> |   |

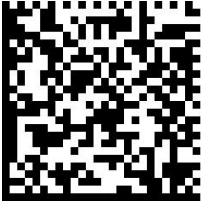
# Reset

| Codes   | Settings and Supported Devices  | Codes   |
|---|---|---|
|  | <p>Reset Scanner to Factory Defaults</p> <p>DM50 • DM60 • DM70 • DM150 • DM260 • DM300 •<br/>DM360 • DM370 • DM470 • DM475V • DM503 •<br/>DM8000 • DM8700 • MX-1000 • MX-1502</p> |   |
|   | <p>Reset Base Station to Factory Defaults</p> <p>DM8000Base (IBASE) • DM8700Base</p>  |  |

# Disable Buttons

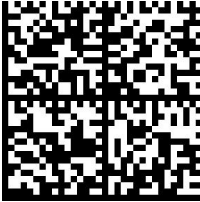



| Codes   | Settings and Supported Devices  | Codes   |
|---|---|---|
|  | <p>Disable Trigger Button</p> <p>DM50 • DM60 • DM70 • DM150 • DM260 • DM300 •<br/>DM360 • DM370 • DM470 • DM503</p> |   |
|   | <p>Disable Tune Button</p> <p>DM50 • DM60 • DM70 • DM150 • DM260 • DM300 •<br/>DM360 • DM370 • DM470 • DM503</p>    |  |

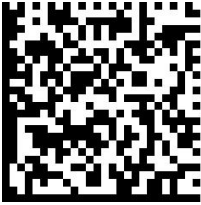
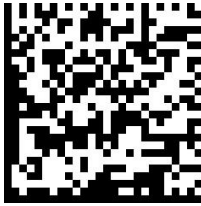



# Diagnostics

| Codes   | Settings and Supported Devices   | Codes   |
|---|--|---|
|  | <p>Output Diagnostic String<br/>(only with RS-232 and USB connections)</p> <p>DM50 • DM60 • DM70 • DM150 • DM260 • DM300 •<br/>DM360 • DM370 • DM470 • DM503 • DM8000 • MX-<br/>1000 • MX-1502</p> |   |
|   | <p>Output Diagnostic String<br/>(through the DM8000 Base Station with RS-232 and USB<br/>connections)</p> <p>DM8000 wireless • DM8700 Base</p>   |  |



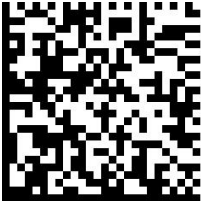

# Setup

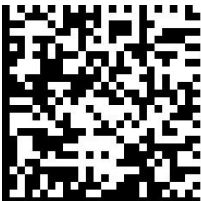
| Codes  | Settings and Supported Devices  | Codes   |
|--|---|---|
|   | <p>Enable Setup 1 Only</p> <ul style="list-style-type: none"> <li>• DM8600 • DM8072 • DM8700</li> </ul> |   |
|  | <p>Enable Setup 2 Only</p> <ul style="list-style-type: none"> <li>• DM8600 • DM8072 • DM8700</li> </ul> |    |
|  | <p>Enable Setup 3 Only</p> <ul style="list-style-type: none"> <li>• DM8600 • DM8072 • DM8700</li> </ul> |   |
|  | <p>Enable Setup 4 Only</p> <ul style="list-style-type: none"> <li>• DM8600 • DM8072</li> </ul>          |  |

# Light Aimer



| Codes  | Settings and Supported Devices  | Codes   |
|--|---|---|
|   | <p>*Light aimer ON<br/>(default for DM50, DM60, and DM8000)</p> <p>DM50 • DM60 • DM70 • DM150 • DM260 • DM300 •<br/>DM360 • DM370 • DM470 • DM8000 • MX-1000 • MX-<br/>1502</p> |   |
|  | <p>Laser Aimer Movement</p> <p>• DM8072</p>   |  |
|  | <p>*Light aimer OFF<br/>(default for DM300)</p> <p>DM50 • DM60 • DM70 • M150 • DM260 • DM300 •<br/>DM360 • DM370 • DM470 • DM8000 • MX-1000 • MX-<br/>1502</p>                  |   |

# Trigger Type

| Codes   | Settings and Supported Devices  | Codes   |
|---|---|---|
|    | <p>Enable Presentation</p> <p>DM50 • DM60 • DM70 • DM150 • DM260 • DM300 • DM360 • DM370 • DM470 • DM503 • DM8000 • MX-1000</p>               |   |
|   | <p>*Enable Manual (button)</p> <p>DM50 • DM60 • DM70 • DM150 • DM260 • DM300 • DM360 • DM370 • DM470 • DM503 • DM8000 • MX-1000 • MX-1502</p> |    |
|   | <p>Enable Single (external)</p> <p>DM50 • DM60 • DM70 • DM150 • DM260 • DM300 • DM360 • DM370 • DM470 • DM503</p>                             |   |
|   | <p>Enable Burst (external)</p> <p>DM50 • DM60 • DM70 • DM150 • DM260 • DM300 • DM360 • DM370 • DM470 • DM503</p>                              |  |
|  | <p>Enable Self (internal)</p> <p>DM50 • DM60 • DM70 • DM150 • DM260 • DM300 • DM360 • DM370 • DM470 • DM503</p>                               |   |



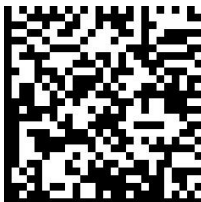

| Codes | Settings and Supported Devices   | Codes   |
|-------|--|---|
|       | <p data-bbox="606 216 931 247">Enable Continuous (external)</p> <p data-bbox="474 359 1064 422">DM50 • DM60 • DM70 • DM150 • DM260 • DM300 •<br/>DM360 • DM370 • DM470 • DM503</p> |  |

# Custom Commands

| Codes  | Settings and Supported Devices   | Codes   |
|--|--|---|
|   | <p>Enable Serial Trigger</p> <p>DM50 • DM60 • DM70 • DM150 • DM260 • DM300 • DM360 • DM370 • DM470 • DM503</p>   |   |
|  | <p>*Disable Serial Trigger</p> <p>DM50 • DM60 • DM70 • DM150 • DM260 • DM300 • DM360 • DM370 • DM470 • DM503</p> |    |
|  | <p>Enable Echo Commands</p> <p>DM50 • DM60 • DM70 • DM150 • DM260 • DM300 • DM360 • DM370 • DM470 • DM503</p>    |   |
|  | <p>*Disable Echo Commands</p> <p>DM50 • DM60 • DM70 • DM150 • DM260 • DM300 • DM360 • DM370 • DM470 • DM503</p>  |  |

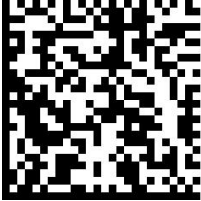
# Maximum Exposure

**Note:** Attempts to set exposure above the highest possible exposure value of the device results in exposure changed to the device maximum.



| Codes   | Settings and Supported Devices  | Codes   |
|---|---|---|
|    | <p>100 µs</p> <p>DM50 • DM60 • DM70 • DM150 • DM260 • DM300 • DM360 • DM370 • DM470 • DM503 • DM8000 • MX-1000 • MX-1502</p>  |   |
|   | <p>133 µs</p> <p>DM50 • DM60 • DM70 • DM150 • DM260 • DM300 • DM360 • DM370 • DM470 • DM503 • DM8000 • MX-1000 • MX-1502</p>  |    |
|  | <p>*170 µs</p> <p>DM50 • DM60 • DM70 • DM150 • DM260 • DM300 • DM360 • DM370 • DM470 • DM503 • DM8000 • MX-1000 • MX-1502</p> |   |
|   | <p>250 µs</p> <p>DM50 • DM60 • DM70 • DM150 • DM260 • DM300 • DM360 • DM370 • DM470 • DM503 • DM8000 • MX-1000 • MX-1502</p>  |  |

| Codes   | Settings and Supported Devices   | Codes   |
|---|--|---|
|    | <p>500 <math>\mu</math>s</p> <p>DM50 • DM60 • DM70 • DM150 • DM260 • DM300 • DM360 • DM370 • DM470 • DM503 • DM8000 • MX-1000 • MX-1502</p>  |   |
|   | <p>800 <math>\mu</math>s</p> <p>DM50 • DM60 • DM70 • DM150 • DM260 • DM300 • DM360 • DM370 • DM470 • DM503 • DM8000 • MX-1000 • MX-1502</p>  |    |
|   | <p>*1000 <math>\mu</math>s<br/>(default for DM50, DM60, DM70, DM300, DM360, DM470, and DM503)</p> <p>DM50 • DM60 • DM70 • DM150 • DM260 • DM300 • DM360 • DM370 • DM470 • DM503 • DM8000 • MX-1000 • MX-1502</p> |   |
|   | <p>2000 <math>\mu</math>s</p> <p>DM50 • DM60 • DM70 • DM150 • DM260 • DM360 • DM370 • DM470 • DM503 • DM8000 • MX-1000 • MX-1502</p>   |  |
|  | <p>*5000 <math>\mu</math>s<br/>(default for MX-1000 and MX-1502 )</p> <p>DM50 • DM60 • DM70 • DM150 • DM260 • DM503 • DM8000 • MX-1000 • MX-1502</p>   |   |







| Codes   | Settings and Supported Devices  | Codes   |
|---|---|---|
|   | <p>8000 <math>\mu</math>s</p> <p>DM50 • DM60 • DM70 • DM150 • DM260 • DM503 •<br/>DM8000 • MX-1000 • MX-1502</p>                            |    |
|    | <p>10000 <math>\mu</math>s</p> <p>DM50 • DM60 • DM70 • DM150 • DM260 • DM503 •<br/>DM8000 • MX-1000 • MX-1502</p>                           |   |
|   | <p>*13333 <math>\mu</math>s<br/>(default for DM8000)</p> <p>DM50 • DM60 • DM70 • DM150 • DM260 • DM503 •<br/>DM8000 • MX-1000 • MX-1502</p> |   |
|  | <p>20000 <math>\mu</math>s</p> <p>DM50 • DM60 • DM70 • DM150 • DM260 • DM503 •<br/>DM8000 • MX-1000 • MX-1502</p>                           |   |
|   | <p>25000 <math>\mu</math>s</p> <p>DM50 • DM60 • DM70 • DM150 • DM260 • DM503 •<br/>DM8000 • MX-1000 • MX-1502</p>                           |  |

# Symbology Settings

| Codes   | Settings and Supported Devices  | Codes   |
|---|---|---|
|    | <p>*Enable ID Max</p> <p>DM50 • DM60 • DM70 • DM150 • DM260 • DM300 • DM360 • DM370 • DM470 • DM503 • DM8700</p>                          |   |
|   | <p>Enable ID Quick</p> <p>DM50 • DM60 • DM70 • DM150 • DM260 • DM300 • DM360 • DM370 • DM470 • DM503 • DM8700</p>                         |    |
|   | <p>*Enable Data Matrix</p> <p>DM50 • DM60 • DM70 • DM150 • DM260 • DM300 • DM360 • DM370 • DM470 • DM503 • DM8000 • MX-1000 • MX-1502</p> |   |
|   | <p>Disable Data Matrix</p> <p>DM50 • DM60 • DM70 • DM150 • DM260 • DM300 • DM360 • DM370 • DM470 • DM503 • DM8000 • MX-1000 • MX-1502</p> |  |
|  | <p>Enable QR Code</p> <p>DM50 • DM60 • DM70 • DM150 • DM260 • DM300 • DM360 • DM370 • DM470 • DM503 • DM8000 • MX-1000 • MX-1502</p>      |   |

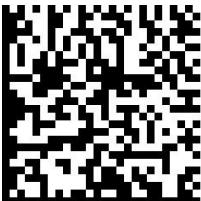
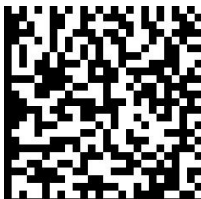



| Codes   | Settings and Supported Devices   | Codes   |
|---|--|---|
|   | <p style="text-align: center;">*Disable QR Code</p> <p>DM50 • DM60 • DM70 • DM150 • DM260 • DM300 • DM360 • DM370 • DM470 • DM503 • DM8000 • MX-1000 • MX-1502</p>         |    |
|    | <p style="text-align: center;">Enable MaxiCode</p> <p>DM50 • DM60 • DM70 • DM150 • DM260 • DM300 • DM360 • DM370 • DM470 • DM503 • DM8050 • DM8600 • DM8072 • DM8700</p>   |   |
|   | <p style="text-align: center;">*Disable MaxiCode</p> <p>DM50 • DM60 • DM70 • DM150 • DM260 • DM300 • DM360 • DM370 • DM470 • DM503 • DM8050 • DM8600 • DM8072 • DM8700</p> |   |
|  | <p style="text-align: center;">Enable Aztec Code</p> <p>DM150 • DM260 • DM300 • DM360 • DM370 • DM470 • DM503 • DM8050 • DM8600 • DM8072 • DM8700</p>                      |   |
|   | <p style="text-align: center;">*Disable Aztec Code</p> <p>DM150 • DM260 • DM300 • DM360 • DM370 • DM470 • DM503 • DM8050 • DM8600 • DM8072 • DM8700</p>                    |  |

| Codes   | Settings and Supported Devices   | Codes   |
|---|--|---|
|    | <p>*Enable Code 128</p> <p>DM50 • DM60 • DM70 • DM150 • DM260 • DM300 • DM360 • DM370 • DM470 • DM503 • DM8000 • MX-1000 • MX-1502</p> |   |
|   | <p>Disable Code 128</p> <p>DM50 • DM60 • DM70 • DM150 • DM260 • DM300 • DM360 • DM370 • DM470 • DM503 • DM8000 • MX-1000 • MX-1502</p> |    |
|   | <p>*Enable UPC/EAN</p> <p>DM50 • DM60 • DM70 • DM150 • DM260 • DM300 • DM360 • DM370 • DM470 • DM503 • DM8000 • MX-1000 • MX-1502</p>  |   |
|   | <p>Disable UPC/EAN</p> <p>DM50 • DM60 • DM70 • DM150 • DM260 • DM300 • DM360 • DM370 • DM470 • DM503 • DM8000 • MX-1000 • MX-1502</p>  |  |
|  | <p>*Enable Code 39</p> <p>DM50 • DM60 • DM70 • DM150 • DM260 • DM300 • DM360 • DM370 • DM470 • DM503 • DM8000 • MX-1000 • MX-1502</p>  |   |

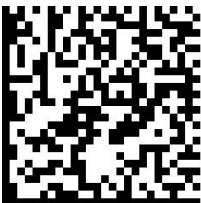



| Codes   | Settings and Supported Devices  | Codes   |
|---|---|---|
|   | <p>Disable Code 39</p> <p>DM50 • DM60 • DM70 • DM150 • DM260 • DM300 • DM360 • DM370 • DM470 • DM503 • DM8000 • MX-1000 • MX-1502</p>             |    |
|    | <p>*Enable Code 93</p> <p>DM50 • DM60 • DM70 • DM150 • DM260 • DM300 • DM360 • DM370 • DM470 • DM503 • DM8000 • MX-1000 • MX-1502 • DM8072</p>    |   |
|   | <p>Disable Code 93</p> <p>DM50 • DM60 • DM70 • DM150 • DM260 • DM300 • DM360 • DM370 • DM470 • DM503 • DM8000 • MX-1000 • MX-1502</p>             |   |
|  | <p>Enable Interleaved 2 of 5</p> <p>DM50 • DM60 • DM70 • DM150 • DM260 • DM300 • DM360 • DM370 • DM470 • DM503 • DM8000</p>                       |   |
|   | <p>*Disable Interleaved 2 of 5</p> <p>DM50 • DM60 • DM70 • DM150 • DM260 • DM300 • DM360 • DM370 • DM470 • DM503 • DM8000 • MX-1000 • MX-1502</p> |  |

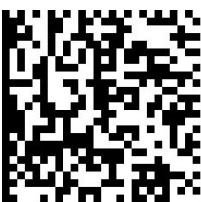

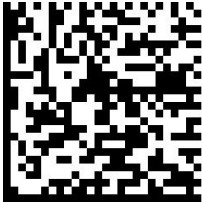

| Codes   | Settings and Supported Devices  | Codes   |
|---|---|---|
|    | <p>*Enable Codabar</p> <p>DM50 • DM60 • DM70 • DM150 • DM260 • DM300 • DM360 • DM370 • DM470 • DM503 • DM8000 • MX-1000 • MX-1502</p>                                   |   |
|   | <p>Disable Codabar</p> <p>DM50 • DM60 • DM70 • DM150 • DM260 • DM300 • DM360 • DM370 • DM470 • DM503 • DM8000 • MX-1000 • MX-1502</p>                                   |    |
|   | <p>Enable Pharmacode<br/>(Not supported on DM8700)</p> <p>DM50 • DM60 • DM70 • DM150 • DM260 • DM300 • DM360 • DM370 • DM470 • DM503 • DM8000 • MX-1000 • MX-1502</p>   |   |
|   | <p>*Disable Pharmacode</p> <p>DM50 • DM60 • DM70 • DM150 • DM260 • DM300 • DM360 • DM370 • DM470 • DM503 • DM8000 • MX-1000 • MX-1502</p>                               |  |
|  | <p>*Enable PDF417<br/>(default for handheld readers)</p> <p>DM50 • DM60 • DM70 • DM150 • DM260 • DM300 • DM360 • DM370 • DM470 • DM503 • DM8000 • MX-1000 • MX-1502</p> |   |

| Codes   | Settings and Supported Devices  | Codes   |
|---|---|---|
|   | <p>*Disable PDF417<br/>(default for fixed-mount readers)</p> <p>DM50 • DM60 • DM70 • DM150 • DM260 • DM300 • DM360 • DM370 • DM470 • DM503 • DM8000 • MX-1000 • MX-1502</p> |    |
|    | <p>Enable Databar<br/>(Not supported on DM8700)</p> <p>DM50 • DM60 • DM70 • DM150 • DM260 • DM300 • DM360 • DM370 • DM470 • DM503 • DM8000 • MX-1000 • MX-1502</p>          |   |
|   | <p>*Disable Databar</p> <p>DM50 • DM60 • DM70 • DM150 • DM260 • DM300 • DM360 • DM370 • DM470 • DM503 • DM8000 • MX-1000 • MX-1502</p>                                      |   |
|  | <p>Enable Micro PDF417<br/>(Not supported on DM8700)</p> <p>DM50 • DM60 • DM70 • DM150 • DM260 • DM300 • DM360 • DM370 • DM470 • DM503 • DM8000 • MX-1000 • MX-1502</p>     |   |
|   | <p>*Disable Micro PDF417</p> <p>DM50 • DM60 • DM70 • DM150 • DM260 • DM300 • DM360 • DM370 • DM470 • DM503 • DM8000 • MX-1000 • MX-1502</p>                                 |  |

| Codes   | Settings and Supported Devices  | Codes   |
|---|---|---|
|    | <p>Enable EAN.UCC Composite<br/>(Not supported on DM8700)</p> <p>DM50 • DM60 • DM70 • DM150 • DM260 • DM300 •<br/>DM360 • DM370 • DM470 • DM503 • DM8000 • MX-<br/>1000 • MX-1502</p> |   |
|   | <p>*Disable EAN.UCC Composite</p> <p>DM50 • DM60 • DM70 • DM150 • DM260 • DM300 •<br/>DM360 • DM370 • DM470 • DM503 • DM8000 • MX-<br/>1000 • MX-1502</p>                             |    |
|   | <p>Enable POSTNET</p> <p>DM50 • DM60 • DM70 • DM150 • DM260 • DM300 •<br/>DM360 • DM370 • DM470 • DM503 • DM8000 • MX-<br/>1000 • MX-1502</p>   |   |
|   | <p>*Disable POSTNET</p> <p>DM50 • DM60 • DM70 • DM150 • DM260 • DM300 •<br/>DM360 • DM370 • DM470 • DM503 • DM8000 • MX-<br/>1000 • MX-1502</p>                                       |  |
|  | <p>Enable PLANET</p> <p>DM50 • DM60 • DM70 • DM150 • DM260 • DM300 •<br/>DM360 • DM370 • DM470 • DM503 • DM8000 • MX-<br/>1000 • MX-1502</p>  |   |





| Codes   | Settings and Supported Devices  | Codes   |
|---|---|---|
|   | <p>*Disable PLANET</p> <p>DM50 • DM60 • DM70 • DM150 • DM260 • DM300 • DM360 • DM370 • DM470 • DM503 • DM8000 • MX-1000 • MX-1502</p>         |    |
|    | <p>Enable Japan Post</p> <p>DM50 • DM60 • DM70 • DM150 • DM260 • DM300 • DM360 • DM370 • DM470 • DM503 • DM8000 • MX-1000 • MX-1502</p>       |   |
|   | <p>*Disable Japan Post</p> <p>DM50 • DM60 • DM70 • DM150 • DM260 • DM300 • DM360 • DM370 • DM470 • DM503 • DM8000 • MX-1000 • MX-1502</p>     |   |
|  | <p>Enable Australia Post</p> <p>DM50 • DM60 • DM70 • DM150 • DM260 • DM300 • DM360 • DM370 • DM470 • DM503 • DM8000 • MX-1000 • MX-1502</p>   |   |
|   | <p>*Disable Australia Post</p> <p>DM50 • DM60 • DM70 • DM150 • DM260 • DM300 • DM360 • DM370 • DM470 • DM503 • DM8000 • MX-1000 • MX-1502</p> |  |

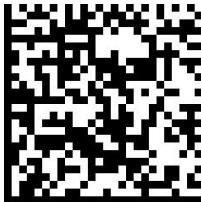
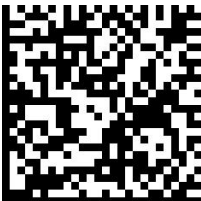
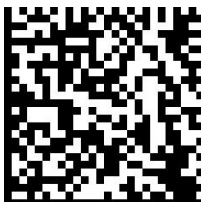
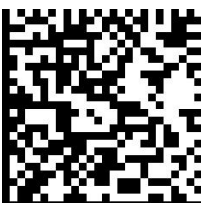

| Codes  | Settings and Supported Devices   | Codes   |
|--|--|---|
|   | <p style="text-align: center;">Enable UPU</p> <p>DM50 • DM60 • DM70 • DM150 • DM260 • DM300 •<br/>DM360 • DM370 • DM470 • DM503 • DM8000 • MX-<br/>1000 • MX-1502</p>                        |   |
|  | <p style="text-align: center;">*Disable UPU</p> <p>DM50 • DM60 • DM70 • DM150 • DM260 • DM300 •<br/>DM360 • DM370 • DM470 • DM503 • DM8000 • MX-<br/>1000 • MX-1502</p>                      |    |
|  | <p style="text-align: center;">Enable Intelligent Mail Barcode</p> <p>DM50 • DM60 • DM70 • DM150 • DM260 • DM300 •<br/>DM360 • DM370 • DM470 • DM503 • DM8000 • MX-<br/>1000 • MX-1502</p>   |   |
|  | <p style="text-align: center;">*Disable Intelligent Mail Barcode</p> <p>DM50 • DM60 • DM70 • DM150 • DM260 • DM300 •<br/>DM360 • DM370 • DM470 • DM503 • DM8000 • MX-<br/>1000 • MX-1502</p> |  |

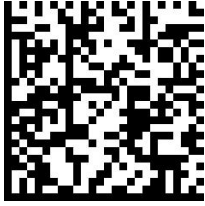

## 2D Symbology Settings

| Codes   | Settings and Supported Devices   | Codes   |
|---|--|---|
|    | <p>Enable Extreme Print Growth<br/>(Data Matrix only)</p> <p>MX-1000 • MX-1502</p>   |   |
|   | <p>*Disable Extreme Print Growth<br/>(Data Matrix only)</p> <p>MX-1000 • MX-1502</p> |    |
|   | <p>DataMatrix Symbol Difficulty - Easy</p> <p>DM8600 • DM8700</p>                    |   |
|   | <p>*DataMatrix Symbol Difficulty - Medium</p> <p>DM8600 • DM8700</p>                 |  |
|  | <p>DataMatrix Symbol Difficulty - Hard</p> <p>DM8600 • DM8700</p>                    |   |

| Codes   | Settings and Supported Devices                              | Codes  |
|---|---|--|
|   | <p>*QR Symbol Difficulty - Easy</p> <p>DM8600 • DM8700</p>  |   |
|  | <p>QR Symbol Difficulty - Medium</p> <p>DM8600 • DM8700</p> |  |
|   | <p>QR Symbol Difficulty - Hard</p> <p>DM8600 • DM8700</p>   |  |

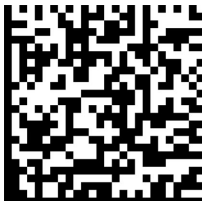

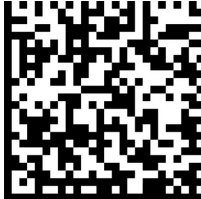
## QR Code Maximum Grid Size

| Codes  | Settings and Supported Devices  | Codes   |
|--|---|---|
|   | <p>*Version 8 (49x49)</p> <p>DM50 • DM60 • DM70 • DM150 • DM260 • DM300 •<br/>DM360 • DM370 • DM470 • DM503 •<br/>MX-1000 • MX-1502 • DM8600 • DM8050 • DM8700</p>              |   |
|  | <p>Version 9 (53x53)</p> <p>DM50 • DM60 • DM70 • DM150 • DM260 • DM300 •<br/>DM360 • DM370 • DM470 • DM503 •<br/>MX-1000 • MX-1502 • DM8600 • DM8050 • DM8700</p>               |    |
|  | <p>Version 10 (57x57)</p> <p>DM50 • DM60 • DM150 • DM260 • DM300 • DM360 •<br/>DM370 • DM470 • DM503 •<br/>MX-1000 • MX-1502 • DM8600 • DM8050 • DM8700</p>                     |   |
|  | <p>Version 12 (65x65)</p> <p>DM50 • DM60 • DM70 • DM150 • DM260 • DM300 •<br/>DM360 • DM370 • DM470 • DM503 •<br/>MX-1000 • MX-1502 • DM8600 • DM8050 • DM8072 •<br/>DM8700</p> |  |

| Codes  | Settings and Supported Devices   | Codes   |
|--|--|---|
|   | <p>Version 16 (81x81)</p> <p>DM50 • DM60 • DM70 • DM150 • DM260 • DM300 •<br/> DM360 • DM370 • DM470 • DM503 •<br/> MX-1000 • MX-1502 • DM8600 • DM8050 • DM8072 •<br/> DM8700</p>   |   |
|  | <p>Version 20 (97x97)</p> <p>DM50 • DM60 • DM70 • DM150 • DM260 • DM300 •<br/> DM360 • DM370 • DM470 • DM503 •<br/> MX-1000 • MX-1502 • DM8600 • DM8050 • DM8072 •<br/> DM8700</p>   |  |
|  | <p>Version 40 (177x177)</p> <p>DM50 • DM60 • DM70 • DM150 • DM260 • DM300 •<br/> DM360 • DM370 • DM470 • DM503 •<br/> MX-1000 • MX-1502 • DM8600 • DM8050 • DM8072 •<br/> DM8700</p> |   |





# 1D Symbology Settings

| Codes   | Settings and Supported Devices  | Codes   |
|---|---|---|
|    | <p>*Enable Use Target Decoding<br/>(simulates laser scanning)<br/>(default for handheld readers except for DM8700)</p> <p>DM8000 • MX-1000 • MX-1502</p>                  |   |
|   | <p>*Disable Use Target Decoding<br/>(simulates laser scanning)<br/>(default for fixed mount readers, DM8000 and MX-1000 • MX-1502 )</p> <p>DM8000 • MX-1000 • MX-1502</p> |    |
|   | <p>*Enable Short Quiet Zone</p> <p>DM50 • DM60 • DM70 • DM150 • DM260 • DM300 • DM360 • DM370 • DM470 • DM503 • DM8000 • MX-1000 • MX-1502</p>                            |   |
|   | <p>Disable Short Quiet Zone</p> <p>DM50 • DM60 • DM70 • DM150 • DM260 • DM300 • DM360 • DM370 • DM470 • DM503 • DM8000 • MX-1000 • MX-1502</p>                            |  |
|  | <p>Code Orientation: Omnidirectional</p> <p>DM50 • DM60 • DM70 • DM150 • DM260 • DM300 • DM360 • DM370 • DM470 • DM503</p>  |   |



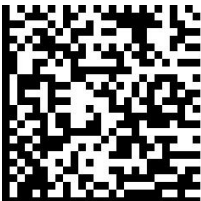

| Codes   | Settings and Supported Devices   | Codes  |
|---|--|--|
|   | <p>Code Orientation: Ladder and Picket Fence</p> <p>DM50 • DM60 • DM70 • DM150 • DM260 • DM300 • DM360 • DM370 • DM470 • DM503</p>   |   |
|  | <p>Code Orientation: Ladder</p> <p>DM50 • DM60 • DM70 • DM150 • DM260 • DM300 • DM360 • DM370 • DM470 • DM503</p>  |  |
|   | <p>Code Orientation: Picket Fence<br/>(for readers which support oriented 1-D reading)</p> <p>DM50 • DM60 • DM70 • DM150 • DM260 • DM300 • DM360 • DM370 • DM470 • DM503</p> |  |



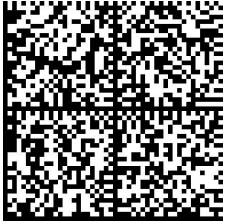

# Training

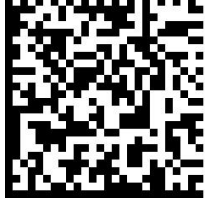

| Codes  | Settings and Supported Devices  | Codes   |
|--|---|---|
|   | <p>Enable incremental training</p> <p>DM50 • DM60 • DM70 • DM150 • DM260 • DM300 • DM360 • DM370 • DM470 • DM503</p>    |   |
|  | <p>*Disable incremental training</p> <p>DM50 • DM60 • DM70 • DM150 • DM260 • DM300 • DM360 • DM370 • DM470 • DM503</p>  |    |
|  | <p>Enable untrained symbologies</p> <p>DM50 • DM60 • DM70 • DM150 • DM260 • DM300 • DM360 • DM370 • DM470 • DM503</p>   |   |
|  | <p>*Disable untrained symbologies</p> <p>DM50 • DM60 • DM70 • DM150 • DM260 • DM300 • DM360 • DM370 • DM470 • DM503</p> |  |

# Data Validation / Data Formatting

| Codes   | Settings and Supported Devices  | Codes   |
|---|---|---|
|    | <p>Enable DoD UID Validation with UII Output</p> <p>DM50 • DM60 • DM70 • DM150 • DM260 • DM300 • DM360 • DM370 • DM470 • DM503 • DM8000 • MX-1000 • MX-1502</p>   |   |
|   | <p>*Disable DoD UID Validation with UII Output</p> <p>DM50 • DM60 • DM70 • DM150 • DM260 • DM300 • DM360 • DM370 • DM470 • DM503 • DM8000 • MX-1000 • MX-1502</p>   |    |
|  | <p>Use Next Code As Match String<br/>(Enable Match String Validation prior to reading this code)</p> <p>DM50 • DM60 • DM70 • DM150 • DM260 • DM300 • DM360 • DM370 • DM470 • DM503 • DM8000 • MX-1000 • MX-1502</p> |   |
|   | <p>Enable Input 1 Save Match String</p> <p>DM50 • DM60 • DM70 • DM150 • DM260 • DM300 • DM360 • DM370 • DM470 • DM503</p>   |  |

| Codes  | Settings and Supported Devices  | Codes   |
|--|---|---|
|   | <p>*Disable Input 1 Save Match String</p> <p>DM50 • DM60 • DM70 • DM150 • DM260 • DM300 • DM360 • DM370 • DM470 • DM503</p> |   |
|  | <p>Enable Button Save Match String</p> <p>DM150 • DM260 • DM300 • DM360 • DM370 • DM470 • DM503</p>                         |  |
|  | <p>*Disable Button Save Match String</p> <p>DM150 • DM260 • DM300 • DM360 • DM370 • DM470 • DM503</p>                       |   |



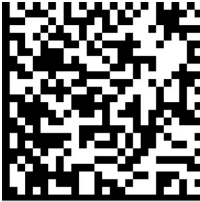
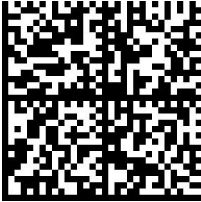
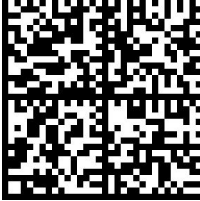
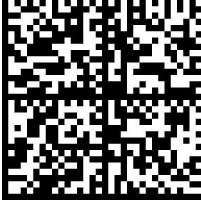

# Non-Printable Characters

| Codes   | Settings and Supported Devices  | Codes   |
|---|---|---|
|  | <p>Enable Translate Unprintable Characters</p> <p>DM50 • DM60 • DM70 • DM150 • DM260 • DM300 • DM360 • DM370 • DM470 • DM503 • DM8000 • MX-1000 • MX-1502</p>   |   |
|   | <p>*Disable Translate Unprintable Characters</p> <p>DM50 • DM60 • DM70 • DM150 • DM260 • DM300 • DM360 • DM370 • DM470 • DM503 • DM8000 • MX-1000 • MX-1502</p> |  |

# Wireless



| Codes   | Settings and Supported Devices  | Codes   |
|---|---|---|
|    | <p>Unassign Reader from Base Station<br/>(Not required for DM8700)</p> <p>DM8000 Wireless</p> |   |
|   | <p>Force Pairing Mode</p> <p>DM8050 • DM8600</p>  |    |
|   | <p>Bluetooth Radio Power Low</p> <p>DM8000Base (IBASE BT)</p>                                 |   |
|   | <p>Bluetooth Radio Power Medium</p> <p>DM8000Base (IBASE BT)</p>                              |  |
|  | <p>Bluetooth Radio Power High</p> <p>DM8000Base (IBASE BT)</p>                                |   |

# Buffering

| Codes   | Settings and Supported Devices  | Codes   |
|---|---|---|
|    | <p>*Enable Offline Buffering<br/>(Not required for DM8700)</p> <p>DM8000 Wireless • MX-1000</p> |   |
|   | <p>Disable Offline Buffering<br/>(Not required for DM8700)</p> <p>DM8000 Wireless • MX-1000</p> |    |
|  | <p>*Offline Buffering Mode - Multiple<br/>(Not required for DM8700)</p> <p>DM8000 Wireless</p>  |   |
|   | <p>Offline Buffering Mode - Single<br/>(Not required for DM8700)</p> <p>DM8000 Wireless</p>     |  |

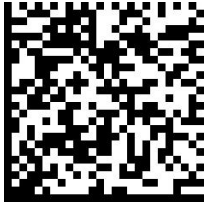

# Power Management

| Codes   | Settings and Supported Devices   | Codes   |
|---|--|---|
|    | <p>Disable Hibernation Mode<br/>(Not supported on DM8700)</p> <p>DM8000 Wireless • MX-1000</p> |   |
|   | <p>*Enable Hibernation Mode<br/>(Not supported on DM8700)</p> <p>DM8000 Wireless • MX-1000</p> |    |
|   | <p>Disable Power Off Mode</p> <p>DM8000 Wireless • MX-1000 • MX-1502</p>                       |   |
|   | <p>Enable Power Off Mode</p> <p>DM8000 Wireless • MX-1000 • MX-1502</p>                        |  |
|  | <p>Power Off Timeout (1 minute)</p> <p>DM8000 Wireless • MX-1000 • MX-1502</p>                 |   |

| Codes   | Settings and Supported Devices   | Codes  |
|---|--|--|
|   | <p>Power Off Timeout (3 minutes)</p> <p>DM8000 Wireless • MX-1000 • MX-1502</p>  |   |
|  | <p>Power Off Timeout (15 minutes)</p> <p>DM8000 Wireless • MX-1000 • MX-1502</p> |  |
|   | <p>Power Off Timeout (30 minutes)</p> <p>DM8000 Wireless • MX-1000 • MX-1502</p> |  |



# Wake-up Message

| Codes   | Settings and Supported Devices   | Codes   |
|---|--|---|
|  | <p>Enable Output Diagnostic String on Wake-up</p> <p>DM50 • DM60 • DM70 • DM150 • DM260 • DM300 • DM360 • DM370 • DM470 • DM503 • DM8000 • MX-1000 • MX-1502</p>   |   |
|   | <p>*Disable Output Diagnostic String on Wake-up</p> <p>DM50 • DM60 • DM70 • DM150 • DM260 • DM300 • DM360 • DM370 • DM470 • DM503 • DM8000 • MX-1000 • MX-1502</p> |  |











# PS/2 Keyboard Emulation Enable











| Codes  | Settings and Supported Devices   | Codes   |
|--|--|---|
|   | <p>PS/2 Keyboard Emulation Enable<br/>(Not supported on DM8700)</p> <p>DM50 • DM70 • DM8000</p> <p><b>DO NOT SCAN this code when you have an actual keyboard connected.</b></p>            |   |
|  | <p>*PS/2 Keyboard Emulation Disable<br/>(Not supported on DM8700)</p> <p>DM50 • DM70 • DM8000</p>  |    |
|  | <p>Base Station PS/2 Keyboard Emulation Enable<br/>(Not supported on DM8700)</p> <p>DM8000Base (IBASE)</p> <p><b>DO NOT SCAN this code when you have an actual keyboard connected.</b></p> |   |
|  | <p>Base Station PS/2 Keyboard Emulation Disable<br/>(Not supported on DM8700)</p> <p>DM8000Base (IBASE)</p>  |  |













# ASCII Keyboard Command Codes









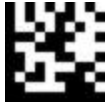

1. Set the data formatting on the DataMan to "Full String".
2. Put the reader into keyboard mode and scan the code. The DataMan will execute this command.







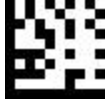

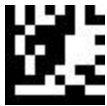

| Codes   | Settings and Supported Devices   | Codes   |
|---|--|---|
|    | <p>ENTER<br/>main ENTER, not numeric keypad ENTER</p> <p>DM50 • DM60 • DM70 • DM8000 • DM8000Base (IBASE) • DM8700Base</p> |   |
|   | <p>ESCAPE</p> <p>DM50 • DM60 • DM70 • DM8000 • DM8000Base (IBASE) • DM8700Base</p>   |    |
|    | <p>BACKSPACE</p> <p>DM50 • DM60 • DM8000 • DM8000Base (IBASE) • DM8700Base</p>   |   |
|   | <p>TAB</p> <p>DM50 • DM60 • DM70 • DM8000 • DM8000Base (IBASE) • DM8700Base</p>  |    |
|   | <p>ALT+A<br/>specifically the left ALT key</p> <p>DM50 • DM60 • DM70 • DM8000 • DM8000Base (IBASE) • DM8700Base</p>        |   |
|   | <p>ALT+B<br/>specifically the left ALT key</p> <p>DM50 • DM60 • DM70 • DM8000 • DM8000Base (IBASE) • DM8700Base</p>        |  |
|  | <p>ALT+C<br/>specifically the left ALT key</p> <p>DM50 • DM60 • DM70 • DM8000 • DM8000Base (IBASE) • DM8700Base</p>        |   |
|   | <p>ALT+D<br/>specifically the left ALT key</p> <p>DM50 • DM60 • DM70 • DM8000 • DM8000Base (IBASE) • DM8700Base</p>        |  |
|  | <p>ALT+E<br/>specifically the left ALT key</p> <p>DM50 • DM60 • DM70 • DM8000 • DM8000Base (IBASE) • DM8700Base</p>        |   |
|   | <p>ALT+F<br/>specifically the left ALT key</p> <p>DM50 • DM60 • DM70 • DM8000 • DM8000Base (IBASE) • DM8700Base</p>        |  |

| Codes   | Settings and Supported Devices  | Codes   |
|---|---|---|
|    | <p>ALT+G<br/>specifically the left ALT key</p> <p>DM50 • DM60 • DM70 • DM8000 • DM8000Base (IBASE) • DM8700Base</p> |   |
|   | <p>ALT+H<br/>specifically the left ALT key</p> <p>DM50 • DM60 • DM70 • DM8000 • DM8000Base (IBASE) • DM8700Base</p> |    |
|    | <p>ALT+I<br/>specifically the left ALT key</p> <p>DM50 • DM60 • DM70 • DM8000 • DM8000Base (IBASE) • DM8700Base</p> |   |
|   | <p>ALT+J<br/>specifically the left ALT key</p> <p>DM50 • DM60 • DM70 • DM8000 • DM8000Base (IBASE) • DM8700Base</p> |    |
|    | <p>ALT+K<br/>specifically the left ALT key</p> <p>DM50 • DM60 • DM70 • DM8000 • DM8000Base (IBASE) • DM8700Base</p> |   |
|   | <p>ALT+L<br/>specifically the left ALT key</p> <p>DM50 • DM60 • DM70 • DM8000 • DM8000Base (IBASE) • DM8700Base</p> |   |
|  | <p>ALT+M<br/>specifically the left ALT key</p> <p>DM50 • DM60 • DM70 • DM8000 • DM8000Base (IBASE) • DM8700Base</p> |   |
|   | <p>ALT+N<br/>specifically the left ALT key</p> <p>DM50 • DM60 • DM70 • DM8000 • DM8000Base (IBASE) • DM8700Base</p> |  |
|  | <p>ALT+O<br/>specifically the left ALT key</p> <p>DM50 • DM60 • DM70 • DM8000 • DM8000Base (IBASE) • DM8700Base</p> |   |
|   | <p>ALT+P<br/>specifically the left ALT ke</p> <p>DM50 • DM60 • DM70 • DM8000 • DM8000Base (IBASE) • DM8700Base</p>  |  |









| Codes   | Settings and Supported Devices  | Codes   |
|---|---|---|
|    | <p>ALT+Q<br/>specifically the left ALT key</p> <p>DM50 • DM60 • DM70 • DM8000 • DM8000Base (IBASE) • DM8700Base</p> |   |
|   | <p>ALT+R<br/>specifically the left ALT key</p> <p>DM50 • DM60 • DM70 • DM8000 • DM8000Base (IBASE) • DM8700Base</p> |    |
|    | <p>ALT+S<br/>specifically the left ALT key</p> <p>DM50 • DM60 • DM70 • DM8000 • DM8000Base (IBASE) • DM8700Base</p> |   |
|   | <p>ALT+T<br/>specifically the left ALT key</p> <p>DM50 • DM60 • DM70 • DM8000 • DM8000Base (IBASE) • DM8700Base</p> |    |
|    | <p>ALT+U<br/>specifically the left ALT key</p> <p>DM50 • DM60 • DM70 • DM8000 • DM8000Base (IBASE) • DM8700Base</p> |   |
|   | <p>ALT+V<br/>specifically the left ALT key</p> <p>DM50 • DM60 • DM70 • DM8000 • DM8000Base (IBASE) • DM8700Base</p> |   |
|  | <p>ALT+W<br/>specifically the left ALT key</p> <p>DM50 • DM60 • DM70 • DM8000 • DM8000Base (IBASE) • DM8700Base</p> |   |
|   | <p>ALT+X<br/>specifically the left ALT key</p> <p>DM50 • DM60 • DM70 • DM8000 • DM8000Base (IBASE) • DM8700Base</p> |  |
|  | <p>ALT+Y<br/>specifically the left ALT key</p> <p>DM50 • DM60 • DM70 • DM8000 • DM8000Base (IBASE) • DM8700Base</p> |   |
|   | <p>ALT+Z<br/>specifically the left ALT key</p> <p>DM50 • DM60 • DM70 • DM8000 • DM8000Base (IBASE) • DM8700Base</p> |  |
|  | <p>PRINTSCREEN</p> <p>DM50 • DM60 • DM70 • DM8000 • DM8000Base (IBASE) • DM8700Base</p>                             |   |











| Codes   | Settings and Supported Devices   | Codes   |
|---|--|---|
|   | <p>F1</p> <p>DM50 • DM60 • DM70 • DM8000 • DM8000Base (IBASE) • DM8700Base</p>       |    |
|    | <p>F2</p> <p>DM50 • DM60 • DM70 • DM8000 • DM8000Base (IBASE) • DM8700Base</p>       |   |
|   | <p>F3</p> <p>DM50 • DM60 • DM70 • DM8000 • DM8000Base (IBASE) • DM8700Base</p>       |    |
|    | <p>F4</p> <p>DM50 • DM60 • DM70 • DM8000 • DM8000Base (IBASE) • DM8700Base</p>       |   |
|   | <p>F5</p> <p>DM50 • DM60 • DM70 • DM8000 • DM8000Base (IBASE) • DM8700Base</p>       |    |
|    | <p>F6</p> <p>DM50 • DM60 • DM70 • DM8000 • DM8000Base (IBASE) • DM8700Base</p>       |   |
|   | <p>F7</p> <p>DM50 • DM60 • DM70 • DM8000 • DM8000Base (IBASE) • DM8700Base</p>       |   |
|  | <p>F8</p> <p>DM50 • DM60 • DM70 • DM8000 • DM8000Base (IBASE) • DM8700Base</p>       |   |
|   | <p>F9</p> <p>DM50 • DM60 • DM70 • DM8000 • DM8000Base (IBASE) • DM8700Base</p>       |  |
|  | <p>F10</p> <p>DM50 • DM60 • DM70 • DM8000 • DM8000Base (IBASE) • DM8700Base</p>      |   |
|   | <p>HOME</p> <p>DM50 • DM60 • DM70 • DM8000 • DM8000Base (IBASE) • DM8700Base</p>     |  |
|  | <p>ARROW UP</p> <p>DM50 • DM60 • DM70 • DM8000 • DM8000Base (IBASE) • DM8700Base</p> |   |
|   | <p>PAGE UP</p> <p>DM50 • DM60 • DM70 • DM8000 • DM8000Base (IBASE) • DM8700Base</p>  |  |

| Codes   | Settings and Supported Devices   | Codes   |
|---|--|---|
|    | <p>ARROW LEFT</p> <p>DM50 • DM60 • DM70 • DM8000 • DM8000Base (IBASE) • DM8700Base</p>                               |   |
|   | <p>ARROW RIGHT</p> <p>DM50 • DM60 • DM70 • DM8000 • DM8000Base (IBASE) • DM8700Base</p>                              |    |
|    | <p>END</p> <p>DM50 • DM60 • DM70 • DM8000 • DM8000Base (IBASE) • DM8700Base</p>                                      |   |
|   | <p>ARROW DOWN</p> <p>DM50 • DM60 • DM70 • DM8000 • DM8000Base (IBASE) • DM8700Base</p>                               |    |
|    | <p>PAGE DOWN</p> <p>DM50 • DM60 • DM70 • DM8000 • DM8000Base (IBASE) • DM8700Base</p>                                |   |
|   | <p>INSERT</p> <p>DM50 • DM60 • DM70 • DM8000 • DM8000Base (IBASE) • DM8700Base</p>                                   |    |
|   | <p>DELETE</p> <p>DM50 • DM60 • DM70 • DM8000 • DM8000Base (IBASE) • DM8700Base</p>                                   |   |
|   | <p>GUI LEFT</p> <p>DM50 • DM60 • DM70 • DM8000 • DM8000Base (IBASE) • DM8700Base</p>                                 |  |
|  | <p>GUI RIGHT</p> <p>DM50 • DM60 • DM70 • DM8000 • DM8000Base (IBASE) • DM8700Base</p>                                |   |
|   | <p>ALT+F1<br/>specifically the left ALT key</p> <p>DM50 • DM60 • DM70 • DM8000 • DM8000Base (IBASE) • DM8700Base</p> |  |
|  | <p>ALT+F2<br/>specifically the left ALT key</p> <p>DM50 • DM60 • DM70 • DM8000 • DM8000Base (IBASE) • DM8700Base</p> |   |
|   | <p>ALT+F3<br/>specifically the left ALT key</p> <p>DM50 • DM60 • DM70 • DM8000 • DM8000Base (IBASE) • DM8700Base</p> |  |











| Codes   | Settings and Supported Devices  | Codes   |
|---|---|---|
|    | <p>ALT+F4<br/>specifically the left ALT key</p> <p>DM50 • DM60 • DM70 • DM8000 • DM8000Base (IBASE) • DM8700Base</p>  |   |
|   | <p>ALT+F5<br/>specifically the left ALT key</p> <p>DM50 • DM60 • DM70 • DM8000 • DM8000Base (IBASE) • DM8700Base</p>  |    |
|    | <p>ALT+F6<br/>specifically the left ALT key</p> <p>DM50 • DM60 • DM70 • DM8000 • DM8000Base (IBASE) • DM8700Base</p>  |   |
|   | <p>ALT+F7<br/>specifically the left ALT key</p> <p>DM50 • DM60 • DM70 • DM8000 • DM8000Base (IBASE) • DM8700Base</p>  |    |
|    | <p>ALT+F8<br/>specifically the left ALT key</p> <p>DM50 • DM60 • DM70 • DM8000 • DM8000Base (IBASE) • DM8700Base</p>  |   |
|   | <p>ALT+F9<br/>specifically the left ALT key</p> <p>DM50 • DM60 • DM70 • DM8000 • DM8000Base (IBASE) • DM8700Base</p>  |   |
|  | <p>ALT+F10<br/>specifically the left ALT key</p> <p>DM50 • DM60 • DM70 • DM8000 • DM8000Base (IBASE) • DM8700Base</p> |   |
|   | <p>F11</p> <p>DM50 • DM60 • DM70 • DM8000 • DM8000Base (IBASE) • DM8700Base</p>                                       |  |
|  | <p>F12</p> <p>DM50 • DM60 • DM70 • DM8000 • DM8000Base (IBASE) • DM8700Base</p>                                       |   |
|   | <p>ALT+F11<br/>specifically the left ALT key</p> <p>DM50 • DM60 • DM70 • DM8000 • DM8000Base (IBASE) • DM8700Base</p> |  |
|  | <p>ALT+F12<br/>specifically the left ALT key</p> <p>DM50 • DM60 • DM70 • DM8000 • DM8000Base (IBASE) • DM8700Base</p> |   |





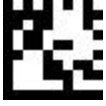

| Codes   | Settings and Supported Devices   | Codes   |
|---|--|---|
|   | <p>ALT+ENTER<br/>specifically the left ALT key and main ENTER</p> <p>DM50 • DM60 • DM70 • DM8000 • DM8000Base (IBASE) • DM8700Base</p> |    |
|    | <p>CTRL+A<br/>specifically the right CTRL key</p> <p>DM50 • DM60 • DM70 • DM8000 • DM8000Base (IBASE) • DM8700Base</p>                 |   |
|   | <p>CTRL+B<br/>specifically the right CTRL key</p> <p>DM50 • DM60 • DM70 • DM8000 • DM8000Base (IBASE) • DM8700Base</p>                 |    |
|    | <p>CTRL+C<br/>specifically the right CTRL key</p> <p>DM50 • DM60 • DM70 • DM8000 • DM8000Base (IBASE) • DM8700Base</p>                 |   |
|   | <p>CTRL+D<br/>specifically the right CTRL key</p> <p>DM50 • DM60 • DM70 • DM8000 • DM8000Base (IBASE) • DM8700Base</p>                 |    |
|   | <p>CTRL+E<br/>specifically the right CTRL key</p> <p>DM50 • DM60 • DM70 • DM8000 • DM8000Base (IBASE) • DM8700Base</p>                 |   |
|   | <p>CTRL+F<br/>specifically the right CTRL key</p> <p>DM50 • DM60 • DM70 • DM8000 • DM8000Base (IBASE) • DM8700Base</p>                 |  |
|  | <p>CTRL+G<br/>specifically the right CTRL key</p> <p>DM50 • DM60 • DM70 • DM8000 • DM8000Base (IBASE) • DM8700Base</p>                 |   |
|   | <p>CTRL+H<br/>specifically the right CTRL key</p> <p>DM50 • DM60 • DM70 • DM8000 • DM8000Base (IBASE) • DM8700Base</p>                 |  |
|  | <p>CTRL+I<br/>specifically the right CTRL key</p> <p>DM50 • DM60 • DM70 • DM8000 • DM8000Base (IBASE) • DM8700Base</p>                 |   |

| Codes   | Settings and Supported Devices   | Codes   |
|---|--|---|
|   | <p>CTRL+J<br/>specifically the right CTRL key</p> <p>DM50 • DM60 • DM70 • DM8000 • DM8000Base (IBASE) • DM8700Base</p> |    |
|    | <p>CTRL+K<br/>specifically the right CTRL key</p> <p>DM50 • DM60 • DM70 • DM8000 • DM8000Base (IBASE) • DM8700Base</p> |   |
|   | <p>CTRL+L<br/>specifically the right CTRL key</p> <p>DM50 • DM60 • DM70 • DM8000 • DM8000Base (IBASE) • DM8700Base</p> |    |
|    | <p>CTRL+M<br/>specifically the right CTRL key</p> <p>DM50 • DM60 • DM70 • DM8000 • DM8000Base (IBASE) • DM8700Base</p> |   |
|   | <p>CTRL+N<br/>specifically the right CTRL key</p> <p>DM50 • DM60 • DM70 • DM8000 • DM8000Base (IBASE) • DM8700Base</p> |    |
|   | <p>CTRL+O<br/>specifically the right CTRL key</p> <p>DM50 • DM60 • DM70 • DM8000 • DM8000Base (IBASE) • DM8700Base</p> |   |
|   | <p>CTRL+P<br/>specifically the right CTRL key</p> <p>DM50 • DM60 • DM70 • DM8000 • DM8000Base (IBASE) • DM8700Base</p> |  |
|  | <p>CTRL+Q<br/>specifically the right CTRL key</p> <p>DM50 • DM60 • DM70 • DM8000 • DM8000Base (IBASE) • DM8700Base</p> |   |
|   | <p>CTRL+R<br/>specifically the right CTRL key</p> <p>DM50 • DM60 • DM70 • DM8000 • DM8000Base (IBASE) • DM8700Base</p> |  |
|  | <p>CTRL+S<br/>specifically the right CTRL key</p> <p>DM50 • DM60 • DM70 • DM8000 • DM8000Base (IBASE) • DM8700Base</p> |   |

| Codes   | Settings and Supported Devices  | Codes   |
|---|---|---|
|   | <p>CTRL+T<br/>specifically the right CTRL key</p> <p>DM50 • DM60 • DM70 • DM8000 • DM8000Base (IBASE) • DM8700Base</p>  |    |
|    | <p>CTRL+U<br/>specifically the right CTRL key</p> <p>DM50 • DM60 • DM70 • DM8000 • DM8000Base (IBASE) • DM8700Base</p>  |   |
|   | <p>CTRL+V<br/>specifically the right CTRL key</p> <p>DM50 • DM60 • DM70 • DM8000 • DM8000Base (IBASE) • DM8700Base</p>  |    |
|    | <p>CTRL+W<br/>specifically the right CTRL key</p> <p>DM50 • DM60 • DM70 • DM8000 • DM8000Base (IBASE) • DM8700Base</p>  |   |
|   | <p>CTRL+X<br/>specifically the right CTRL key</p> <p>DM50 • DM60 • DM70 • DM8000 • DM8000Base (IBASE) • DM8700Base</p>  |    |
|   | <p>CTRL+Y<br/>specifically the right CTRL key</p> <p>DM50 • DM60 • DM70 • DM8000 • DM8000Base (IBASE) • DM8700Base</p>  |   |
|   | <p>CTRL+Z<br/>specifically the right CTRL key</p> <p>DM50 • DM60 • DM70 • DM8000 • DM8000Base (IBASE) • DM8700Base</p>  |  |
|  | <p>CTRL+F1<br/>specifically the right CTRL key</p> <p>DM50 • DM60 • DM70 • DM8000 • DM8000Base (IBASE) • DM8700Base</p> |   |
|   | <p>CTRL+F2<br/>specifically the right CTRL key</p> <p>DM50 • DM60 • DM70 • DM8000 • DM8000Base (IBASE) • DM8700Base</p> |  |
|  | <p>CTRL+F3<br/>specifically the right CTRL key</p> <p>DM50 • DM60 • DM70 • DM8000 • DM8000Base (IBASE) • DM8700Base</p> |   |

| Codes   | Settings and Supported Devices  | Codes   |
|---|---|---|
|   | <p>CTRL+F4<br/>specifically the right CTRL key</p> <p>DM50 • DM60 • DM70 • DM8000 • DM8000Base (IBASE) • DM8700Base</p>                   |    |
|    | <p>CTRL+F5<br/>specifically the right CTRL key</p> <p>DM50 • DM60 • DM70 • DM8000 • DM8000Base (IBASE) • DM8700Base</p>                   |   |
|   | <p>CTRL+F6<br/>specifically the right CTRL key</p> <p>DM50 • DM60 • DM70 • DM8000 • DM8000Base (IBASE) • DM8700Base</p>                   |    |
|    | <p>CTRL+F7<br/>specifically the right CTRL key</p> <p>DM50 • DM60 • DM70 • DM8000 • DM8000Base (IBASE) • DM8700Base</p>                   |   |
|   | <p>CTRL+F8<br/>specifically the right CTRL key</p> <p>DM50 • DM60 • DM70 • DM8000 • DM8000Base (IBASE) • DM8700Base</p>                   |    |
|   | <p>CTRL+F9<br/>specifically the right CTRL key</p> <p>DM50 • DM60 • DM70 • DM8000 • DM8000Base (IBASE) • DM8700Base</p>                   |   |
|   | <p>CTRL+F10<br/>specifically the right CTRL key</p> <p>DM50 • DM60 • DM70 • DM8000 • DM8000Base (IBASE) • DM8700Base</p>                  |  |
|  | <p>CTRL+F11<br/>specifically the right CTRL key</p> <p>DM50 • DM60 • DM70 • DM8000 • DM8000Base (IBASE) • DM8700Base</p>                  |   |
|   | <p>CTRL+F12<br/>specifically the right CTRL key</p> <p>DM50 • DM60 • DM70 • DM8000 • DM8000Base (IBASE) • DM8700Base</p>                  |  |
|  | <p>CTRL+ENTER<br/>specifically the right CTRL key and main ENTER</p> <p>DM50 • DM60 • DM70 • DM8000 • DM8000Base (IBASE) • DM8700Base</p> |   |

| Codes   | Settings and Supported Devices   | Codes   |
|---|--|---|
|   | <p style="text-align: center;">CTRL<br/>specifically the right CTRL key</p> <p>DM50 • DM60 • DM70 • DM8000 • DM8000Base (IBASE) • DM8700Base</p>     |    |
|    | <p style="text-align: center;">SHIFT+F1<br/>specifically the left SHIFT key</p> <p>DM50 • DM60 • DM70 • DM8000 • DM8000Base (IBASE) • DM8700Base</p> |   |
|   | <p style="text-align: center;">SHIFT+F2<br/>specifically the left SHIFT key</p> <p>DM50 • DM60 • DM70 • DM8000 • DM8000Base (IBASE) • DM8700Base</p> |    |
|    | <p style="text-align: center;">SHIFT+F3<br/>specifically the left SHIFT key</p> <p>DM50 • DM60 • DM70 • DM8000 • DM8000Base (IBASE) • DM8700Base</p> |   |
|   | <p style="text-align: center;">SHIFT+F4<br/>specifically the left SHIFT key</p> <p>DM50 • DM60 • DM70 • DM8000 • DM8000Base (IBASE) • DM8700Base</p> |    |
|   | <p style="text-align: center;">SHIFT+F5<br/>specifically the left SHIFT key</p> <p>DM50 • DM60 • DM70 • DM8000 • DM8000Base (IBASE) • DM8700Base</p> |   |
|   | <p style="text-align: center;">SHIFT+F6<br/>specifically the left SHIFT key</p> <p>DM50 • DM60 • DM70 • DM8000 • DM8000Base (IBASE) • DM8700Base</p> |  |
|  | <p style="text-align: center;">SHIFT+F7<br/>specifically the left SHIFT key</p> <p>DM50 • DM60 • DM70 • DM8000 • DM8000Base (IBASE) • DM8700Base</p> |   |
|   | <p style="text-align: center;">SHIFT+F8<br/>specifically the left SHIFT key</p> <p>DM50 • DM60 • DM70 • DM8000 • DM8000Base (IBASE) • DM8700Base</p> |  |
|  | <p style="text-align: center;">SHIFT+F9<br/>specifically the left SHIFT key</p> <p>DM50 • DM60 • DM70 • DM8000 • DM8000Base (IBASE) • DM8700Base</p> |   |

| Codes   | Settings and Supported Devices   | Codes   |
|---|--|---|
|   | <p style="text-align: center;">SHIFT+F10<br/>specifically the left SHIFT key</p> <p>DM50 • DM60 • DM70 • DM8000 • DM8000Base (IBASE) • DM8700Base</p>                  |  |
|  | <p style="text-align: center;">SHIFT+F11<br/>specifically the left SHIFT key</p> <p>DM50 • DM60 • DM70 • DM8000 • DM8000Base (IBASE) • DM8700Base</p>                  |   |
|   | <p style="text-align: center;">SHIFT+F12<br/>specifically the left SHIFT key</p> <p>DM50 • DM60 • DM70 • DM8000 • DM8000Base (IBASE) • DM8700Base</p>                  |  |
|  | <p style="text-align: center;">SHIFT+ENTER<br/>specifically the left SHIFT key and main ENTER</p> <p>DM50 • DM60 • DM70 • DM8000 • DM8000Base (IBASE) • DM8700Base</p> |   |



# iOS Keyboard Configuration

| Codes   | Settings and Supported Devices  | Codes   |
|---|---|---|
|    | <p>Enable iOS Keyboard Emulation</p> <p>MX-1000 • MX-1502</p>           |   |
|   | <p>Disable iOS Keyboard Emulation</p> <p>MX-1000 • MX-1502</p>          |    |
|   | <p>Set iOS Keyboard Warm-Up Time to 300ms</p> <p>MX-1000 • MX-1502</p>  |   |
|   | <p>Set iOS Keyboard Warm-Up Time to 500ms</p> <p>MX-1000 • MX-1502</p>  |  |
|  | <p>Set iOS Keyboard Warm-Up Time to 1000ms</p> <p>MX-1000 • MX-1502</p> |   |



# USB Connection

| Codes   | Settings and Supported Devices   | Codes   |
|---|--|---|
|    | <p>*USB-COM/RS-232</p> <p>DM50 • DM60 • DM70 • DM150 • DM8050 • DM8072 • DM8600 • MX-1000 • MX-1502</p>  |   |
|   | <p>USB Keyboard</p> <p>DM50 • DM60 • DM70 • DM150 • DM8050 • DM8072 • DM8600 • MX-1000 • MX-1502</p>   |    |
|   | <p>Enable USB Keyboard for the base station</p> <p><i>Reboot needed for enabling USB keyboard for the base station!</i></p> <p>DM8000Base (IBASE)</p>      |   |
|   | <p>*Disable USB Keyboard for the base station</p> <p><i>Reboot needed after disabling USB keyboard for the base station!</i></p> <p>DM8000Base (IBASE)</p> |  |
|  | <p>Enable 'Enumerate in HID mode only'</p> <p><i>Reboot needed for changing between HID and USB mode of base/reader!</i></p> <p>DM8000Base (IBASE)</p>     |   |

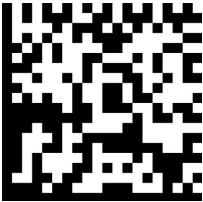

| Codes   | Settings and Supported Devices  | Codes   |
|---|---|---|
|   | <p>Disable 'Enumerate in HID mode only'</p> <p><i>Reboot needed for changing between HID and USB mode of base/reader!</i></p> <p>DM8000Base (IBASE)</p> |    |
|    | <p>Enable HID mode (USB Keyboard)</p> <p><i>No restart required, device does not lose cdc communication channel.</i></p> <p>DM8700</p>                  |   |
|   | <p>Disable HID mode (USB Keyboard)</p> <p><i>No restart required, device does not lose cdc communication channel.</i></p> <p>DM8700</p>                 |   |
|  | <p>Enable HID mode (USB Keyboard)</p> <p>DM8700Base</p>   |   |
|   | <p>Disable HID mode (USB Keyboard)</p> <p>DM8700Base</p>  |  |

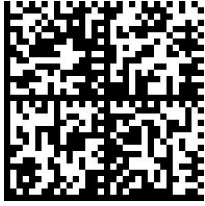
| Codes   | Settings and Supported Devices  | Codes   |
|---|---|---|
|    | <p>*Enable Base USB</p> <p><i>Reader switches to USB when in the base.</i></p> <p>DM8000Base (IBASE)</p>          |   |
|   | <p>Disable Base USB</p> <p><i>Reader keeps up WiFi even when in the base.</i></p> <p>DM8000Base (IBASE Wi-Fi)</p> |    |
|   | <p>Enable Re-enumeration on Firmware Start</p> <p>DM50 • DM60 • DM70 • DM150</p>                                  |   |
|   | <p>Disable Re-enumeration on Firmware Start</p> <p>DM50 • DM60 • DM70 • DM150</p>                                 |  |
|  | <p>DTR Assertion Required for USB communication</p> <p>DM8050 • DM8700 corded</p>                                 |   |





| Codes   | Settings and Supported Devices  | Codes  |
|---|---|--|
|   | <p>DTR Assertion Not Required for USB communication</p> <p>DM8050 • DM8700 corded</p> |   |
|  | <p>HID Ignore Caps Lock ON</p> <p>DM8700</p>  |  |
|   | <p>HID Ignore Caps Lock OFF</p> <p>DM8700</p>   |  |

# USB Mode



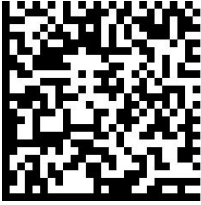

| Codes   | Settings and Supported Devices  | Codes   |
|---|---|---|
|    | USB compatibility mode enabled<br>(Not supported on DM8700)<br><br>DM50 • DM70 • DM8000   |   |
|   | *USB compatibility mode disabled<br>(Not supported on DM8700)<br><br>DM50 • DM70 • DM8000 |    |
|   | USB compatibility mode enabled<br><br>DM8000Base (IBASE)                                  |   |
|   | USB compatibility mode disabled<br><br>DM8000Base (IBASE)                                 |  |
|  | USB 2.0 mode<br>(Not supported on DM8700)<br><br>DM50 • DM70 • DM150 • DM8000             |   |

| Codes   | Settings and Supported Devices   | Codes   |
|---|--|---|
|   | <p>*USB 1.1 mode<br/>(Not supported on DM8700)</p> <p>DM50 • DM70 • DM150 • DM8000</p>                             |    |
|    | <p>USB 2.0 mode on base station</p> <p>DM50 • DM70 • DM150 • DM8000Base (IBASE)</p>                                |   |
|   | <p>*USB 1.1 mode on base station<br/>(Not supported on DM8700)</p> <p>DM50 • DM70 • DM150 • DM8000Base (IBASE)</p> |   |
|  | <p>Android Mode<br/>(default)</p> <p>MX-1000 • MX-1502</p>   |   |
|   | <p>iOS Mode</p> <p>MX-1000 • MX-1502</p>   |  |

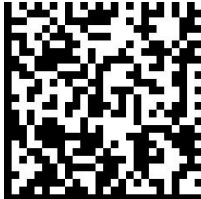
# Communications

| Codes   | Settings and Supported Devices   | Codes   |
|---|--|---|
|    | <p>*Enable DHCP<br/>(default for all Ethernet readers)</p> <p>DM60 • DM150 • DM260 • DM300 • DM360 • DM370 •<br/>DM470 • DM503 • DM8000</p> <p><b>DO NOT SCAN this code with a DM8000 wireless reader!</b></p> |   |
|   | <p>Enable Multi-Port (RS-232 Sharing)</p> <p>DM50 • DM60 • DM70 • DM150 • DM260 • DM300 •<br/>DM360 • DM370 • DM470 • DM503</p>  |    |
|  | <p>*Disable Multi-Port (RS-232 Sharing)</p> <p>DM50 • DM60 • DM70 • DM150 • DM260 • DM300 •<br/>DM360 • DM370 • DM470 • DM503</p>  |   |
|   | <p>Enable EtherNet/IP</p> <p>DM60 • DM150 • DM260 • DM300 • DM360 • DM370 •<br/>DM470 • DM503 • DM8000 (corded)</p>  |  |





| Codes   | Settings and Supported Devices  | Codes   |
|---|---|---|
|    | <p>Enable EtherNet/IP</p> <p>DM8000Base (IBASE BT + Wi-Fi) • DM8700Base</p>   |   |
|   | <p>*Disable EtherNet/IP</p> <p>DM60 • DM150 • DM260 • DM300 • DM360 • DM370 •<br/>DM470 • DM503 • DM8000 (corded)</p> |    |
|   | <p>*Disable EtherNet/IP</p> <p>DM8000Base (IBASE BT + Wi-Fi) • DM8700Base</p>   |   |
|   | <p>Enable PROFINET</p> <p>DM60 • DM150 • DM260 • DM300 • DM360 • DM370 •<br/>DM470 • DM503 • DM8000 (corded)</p>      |  |
|  | <p>Enable PROFINET</p> <p>DM8000Base (IBASE BT + Wi-Fi) • DM8700Base</p>  |   |



| Codes   | Settings and Supported Devices   | Codes   |
|---|--|---|
|   | <p>*Disable PROFINET</p> <p>DM60 • DM150 • DM260 • DM300 • DM360 • DM370 • DM470 • DM503 • DM8000 (corded)</p>   |    |
|    | <p>*Disable PROFINET</p> <p>DM8000Base (IBASE BT + Wi-Fi) • DM8700Base</p>                                       |   |
|   | <p>Enable Modbus TCP</p> <p>DM60 • DM150 • DM260 • DM300 • DM360 • DM370 • DM470 • DM503 • DM8000 (corded)</p>   |   |
|  | <p>Enable Modbus TCP</p> <p>DM8000Base (IBASE BT + Wi-Fi) • DM8700Base</p>                                       |   |
|   | <p>*Disable Modbus TCP</p> <p>DM60 • DM150 • DM260 • DM300 • DM360 • DM370 • DM470 • DM503 • DM8000 (corded)</p> |  |





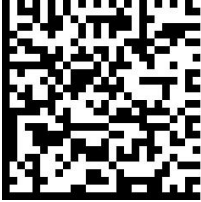

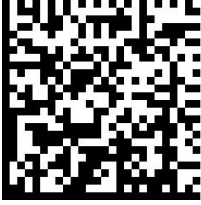
| Codes   | Settings and Supported Devices  | Codes   |
|---|---|---|
|    | <p>*Disable Modbus TCP</p> <p>DM8000Base (IBASE BT + Wi-Fi) • DM8700Base</p>  |   |
|   | <p>Enable SLMP Protocol</p> <p>DM60 • DM150 • DM260 • DM300 • DM360 • DM370 •<br/>DM470 • DM503 • DM8000 (corded)</p>   |    |
|   | <p>Enable SLMP Protocol</p> <p>DM8000Base (IBASE BT + Wi-Fi) • DM8700Base</p>   |   |
|   | <p>*Disable SLMP Protocol</p> <p>DM60 • DM150 • DM260 • DM300 • DM360 • DM370 •<br/>DM470 • DM503 • DM8000 (corded)</p> |  |
|  | <p>*Disable SLMP Protocol</p> <p>DM8000Base (IBASE BT + Wi-Fi) • DM8700Base</p>   |   |

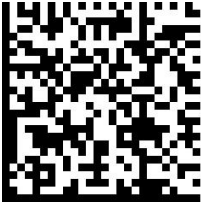
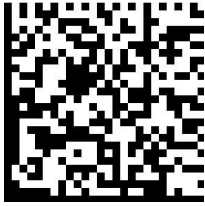

# RS-232 Baud Rate

| Codes   | Settings and Supported Devices   | Codes   |
|---|--|---|
|    | <p>9600 BPS</p> <p>DM50 • DM60 • DM70 • DM150 • DM260 • DM300 • DM360 • DM370 • DM470 • DM503 • DM8000 (corded)</p>  |   |
|   | <p>9600 BPS</p> <p>DM8000Base (IBASE BT + Wi-Fi) • DM8700Base</p>  |    |
|   | <p>19200 BPS</p> <p>DM50 • DM60 • DM70 • DM150 • DM260 • DM300 • DM360 • DM370 • DM470 • DM503 • DM8000 (corded)</p> |   |
|   | <p>19200 BPS</p> <p>DM8000Base (IBASE BT + Wi-Fi) • DM8700Base</p>   |  |
|  | <p>38400 BPS</p> <p>DM50 • DM60 • DM70 • DM150 • DM260 • DM300 • DM360 • DM370 • DM470 • DM503 • DM8000 (corded)</p> |   |



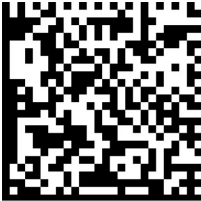

| Codes   | Settings and Supported Devices   | Codes   |
|---|--|---|
|   | <p>38400 BPS</p> <p>DM8000Base (IBASE BT + Wi-Fi) • DM8700Base</p>   |    |
|    | <p>*57600 BPS<br/>(default for DMAE50, DM300, DM360, DM470 and DM8000)</p> <p>DM50 • DM60 • DM70 • DM150 • DM260 • DM300 • DM360 • DM370 • DM470 • DM503 • DM8000 (corded)</p>     |   |
|   | <p>57600 BPS</p> <p>DM8000Base (IBASE BT + Wi-Fi)</p>  |   |
|  | <p>*115200 BPS<br/>(default for DM50, DM60, DM70, DM150, DM260, and DM503)</p> <p>DM50 • DM60 • DM70 • DM150 • DM260 • DM300 • DM360 • DM370 • DM470 • DM503 • DM8050 • DM8600</p> |   |
|   | <p>115200 BPS</p> <p>DM8000Base (IBASE BT + Wi-Fi) • DM8700Base</p>  |  |

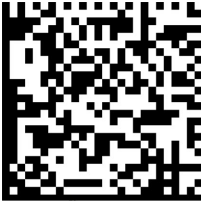
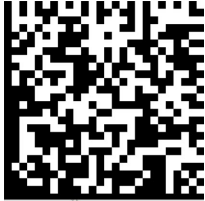
# RS-232 Parity Settings



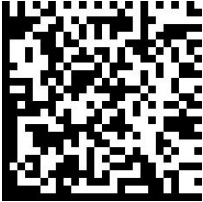

| Codes   | Settings and Supported Devices                                | Codes   |
|---|---|---|
|    | <p>None</p> <p>All readers</p>                                |   |
|   | <p>None</p> <p>DM8000Base (IBASE BT + Wi-Fi) • DM8700Base</p> |    |
|   | <p>Odd</p> <p>All readers</p>                                 |   |
|   | <p>Odd</p> <p>DM8000Base (IBASE BT + Wi-Fi) • DM8700Base</p>  |  |
|  | <p>Even</p> <p>All readers</p>                                |   |

| Codes   | Settings and Supported Devices   | Codes   |
|---|--|---|
|   | <p style="text-align: center;">Even</p> <p style="text-align: center;">DM8000Base (IBASE BT + Wi-Fi) • DM8700Base</p>  |    |
|    | <p style="text-align: center;">Mark</p> <p style="text-align: center;">DM8050 • DM8600</p>                             |   |
|   | <p style="text-align: center;">Mark</p> <p style="text-align: center;">DM8000Base (IBASE BT + Wi-Fi) • DM8700Base</p>  |   |
|  | <p style="text-align: center;">Space</p> <p style="text-align: center;">DM8050 • DM8600</p>                            |   |
|   | <p style="text-align: center;">Space</p> <p style="text-align: center;">DM8000Base (IBASE BT + Wi-Fi) • DM8700Base</p> |  |





# RS-232 Databit Settings

| Codes  | Settings and Supported Devices   | Codes   |
|--|--|---|
|   | <p style="text-align: center;">Databit 7</p> <p>DM50 • DM60 • DM70 • DM150 • DM260 • DM300 •<br/>DM360 • DM370 • DM470 • DM503 • DM8000 (corded)</p> |   |
|  | <p style="text-align: center;">Databit 7</p> <p>DM8000Base (IBASE BT + Wi-Fi) • DM8700Base</p>   |    |
|  | <p style="text-align: center;">Databit 8</p> <p>DM50 • DM60 • DM70 • DM150 • DM260 • DM300 •<br/>DM360 • DM370 • DM470 • DM503 • DM8000 (corded)</p> |   |
|  | <p style="text-align: center;">Databit 8</p> <p>DM8000Base (IBASE BT + Wi-Fi) • DM8700Base</p>   |  |

# RS-232 Stopbit Settings



| Codes  | Settings and Supported Devices   | Codes   |
|--|--|---|
|   | <p style="text-align: center;">Stopbit 1</p> <p>DM50 • DM60 • DM70 • DM150 • DM260 • DM300 • DM360 • DM370 • DM470 • DM503 • DM8000 (corded)</p> |   |
|  | <p style="text-align: center;">Stopbit 1</p> <p>DM8000Base (IBASE BT + Wi-Fi) • DM8700Base</p>   |    |
|  | <p style="text-align: center;">Stopbit 2</p> <p>DM50 • DM60 • DM70 • DM150 • DM260 • DM300 • DM360 • DM370 • DM470 • DM503 • DM8000 (corded)</p> |   |
|  | <p style="text-align: center;">Stopbit 2</p> <p>DM8000Base (IBASE BT + Wi-Fi) • DM8700Base</p>   |  |

# RS-232 Handshaking

| Codes  | Settings and Supported Devices                                       | Codes   |
|--|--|---|
|   | <p>*RTS/CTS Off</p> <p>DM8000 (corded)</p>                           |   |
|  | <p>RTS/CTS Off</p> <p>DM8000Base (IBASE BT + Wi-Fi) • DM8700Base</p> |    |
|  | <p>RTS/CTS On</p> <p>DM8000 (corded)</p>                             |   |
|  | <p>RTS/CTS On</p> <p>DM8000Base (IBASE BT + Wi-Fi) • DM8700Base</p>  |  |



# RS-232 Routing

| Codes   | Settings and Supported Devices  | Codes   |
|---|---|---|
|  | <p>*Route to associated reader<br/>(Not supported on DM8700)</p> <p>DM8000 (wireless)</p> |   |
|   | <p>Route to base station<br/>(Not supported on DM8700)</p> <p>DM8000 (wireless)</p>       |  |



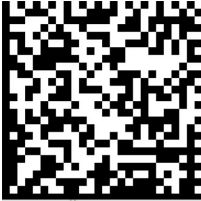
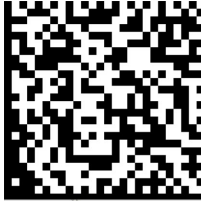

# Network Settings

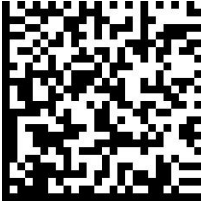
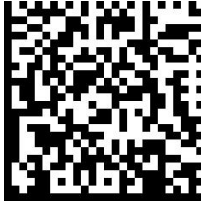
| Codes   | Settings and Supported Devices   | Codes   |
|---|--|---|
|  | <p>Enable Network Client<br/>(only corded Ethernet connections)</p> <p>DM60 • DM150 • DM260 • DM300 • DM360 • DM370 •<br/>DM470 • DM503 • DM8000</p>   |   |
|   | <p>*Disable Network Client<br/>(only corded Ethernet connections)</p> <p>DM60 • DM150 • DM260 • DM300 • DM360 • DM370 •<br/>DM470 • DM503 • DM8000</p> |  |



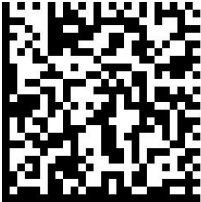

# Decode Settings





| Codes   | Settings and Supported Devices  | Codes   |
|---|---|---|
|  | <p>*Never Read the Same Code Twice Off</p> <p>DM50 • DM60 • DM70 • DM150 • DM260 • DM300 •<br/>DM360 • DM370 • DM470 • DM503 • DM8000</p> |   |
|   | <p>Never Read the Same Code Twice On</p> <p>DM50 • DM60 • DM70 • DM150 • DM260 • DM300 •<br/>DM360 • DM370 • DM470 • DM503 • DM8000</p>   |  |





# Multi-Reader Sync



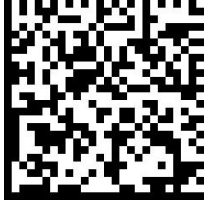

| Codes  | Settings and Supported Devices   | Codes   |
|--|--|---|
|   | <p>Enable MRS</p> <p>DM60 • DM150 • DM260 • DM300 • DM360 • DM370 •<br/>DM470 • DM503</p>                        |   |
|  | <p>*Disable MRS</p> <p>DM60 • DM150 • DM260 • DM300 • DM360 • DM370 •<br/>DM470 • DM503</p>                      |    |
|  | <p>Select Reader as Primary Reader</p> <p>DM60 • DM150 • DM260 • DM300 • DM360 • DM370 •<br/>DM470 • DM503</p>   |   |
|  | <p>Deselect Reader as Primary Reader</p> <p>DM60 • DM150 • DM260 • DM300 • DM360 • DM370 •<br/>DM470 • DM503</p> |  |

# Keyboard Layout





| Codes   | Settings and Supported Devices   | Codes   |
|---|--|---|
|    | <p>*USA</p> <p>DM50 • DM60 • DM70 • DM150 • DM260 • DM8000 • DM8700</p>    |   |
|   | <p>*USA</p> <p>DM8000Base (IBASE BT + Wi-Fi) • DM8700Base</p>              |    |
|   | <p>Germany</p> <p>DM50 • DM60 • DM70 • DM150 • DM260 • DM8000 • DM8700</p> |   |
|   | <p>Germany</p> <p>DM8000Base (IBASE BT + Wi-Fi) • DM8700Base</p>           |  |
|  | <p>France</p> <p>DM50 • DM60 • DM70 • DM150 • DM260 • DM8000 • DM8700</p>  |   |

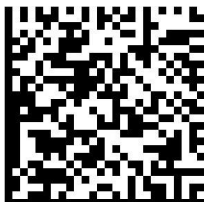

| Codes   | Settings and Supported Devices   | Codes   |
|---|--|---|
|   | <p style="text-align: center;">France</p> <p style="text-align: center;">DM8000Base (IBASE BT + Wi-Fi) • DM8700Base</p>          |    |
|    | <p style="text-align: center;">Spain</p> <p style="text-align: center;">DM50 • DM60 • DM70 • DM150 • DM260 • DM8000 • DM8700</p> |   |
|   | <p style="text-align: center;">Spain</p> <p style="text-align: center;">DM8000Base (IBASE BT + Wi-Fi) • DM8700Base</p>           |   |
|  | <p style="text-align: center;">Japan</p> <p style="text-align: center;">DM50 • DM60 • DM70 • DM150 • DM260 • DM8000 • DM8700</p> |   |
|   | <p style="text-align: center;">Japan</p> <p style="text-align: center;">DM8000Base (IBASE BT + Wi-Fi) • DM8700Base</p>           |  |

| Codes   | Settings and Supported Devices   | Codes   |
|---|--|---|
|    | <p>Norway</p> <p>DM50 • DM60 • DM70 • DM150 • DM260 • DM8000</p>         |   |
|   | <p>Norway</p> <p>DM8000Base (IBASE BT + Wi-Fi) • DM8700Base</p>          |    |
|   | <p>Finland</p> <p>DM50 • DM60 • DM70 • DM150 • DM260 • DM8000</p>        |   |
|   | <p>Finland</p> <p>DM8000Base (IBASE BT + Wi-Fi) • DM8700Base</p>         |  |
|  | <p>Czech Republic</p> <p>DM50 • DM60 • DM70 • DM150 • DM260 • DM8700</p> |   |



| Codes   | Settings and Supported Devices                                    | Codes   |
|---|---|---|
|   | <p>Czech Republic</p> <p>DM8700Base</p>                           |    |
|    | <p>Hungary</p> <p>DM50 • DM60 • DM70 • DM150 • DM260 • DM8700</p> |   |
|   | <p>Hungary</p> <p>DM8700Base</p>                                  |   |
|  | <p>Italy</p> <p>DM50 • DM60 • DM70 • DM150 • DM260 • DM8700</p>   |   |
|   | <p>Italy</p> <p>DM8700Base</p>                                    |  |

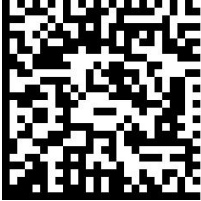

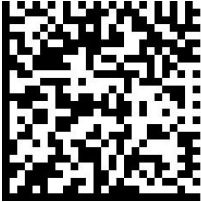

| Codes   | Settings and Supported Devices   | Codes   |
|---|--|---|
|    | <p>Set HID Language to Spanish (ES) (Xkb)</p> <p>DM50 • DM60 • DM70 • DM150 • DM260</p>    |   |
|   | <p>Set HID Language to Czech (CZ) (Xkb)</p> <p>DM50 • DM60 • DM70 • DM150 • DM260</p>      |    |
|   | <p>Set HID Language to Italian (IT) (Xkb)</p> <p>DM50 • DM60 • DM70 • DM150 • DM260</p>    |   |
|   | <p>Set HID Language to English (UK) (Xkb)</p> <p>DM50 • DM60 • DM70 • DM150 • DM260</p>    |  |
|  | <p>Set HID Language to Portuguese (BR) (Xkb)</p> <p>DM50 • DM60 • DM70 • DM150 • DM260</p> |   |

| Codes   | Settings and Supported Devices  | Codes  |
|---|---|--|
|   | <p>Set HID Language to Spanish (MX) (Xkb)</p> <p>DM50 • DM60 • DM70 • DM150 • DM260</p> |   |
|  | <p>Alt Key Combo</p> <p>DM50 • DM70 • DM8000</p>  |  |
|   | <p>Alt Key Combo</p> <p>DM8000Base (IBASE BT + Wi-Fi) • DM8700Base</p>                  |  |



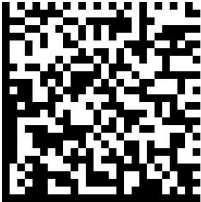

# Alt Key Combo Zero Padding

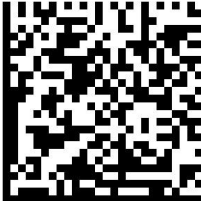
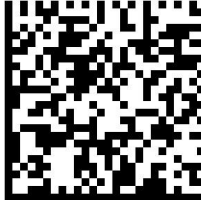



| Codes  | Settings and Supported Devices  | Codes   |
|--|---|---|
|   | <p>*Enable Alt Key Combo Zero Padding</p> <p>DM50 • DM70 • DM8000</p>                       |   |
|  | <p>*Enable Alt Key Combo Zero Padding</p> <p>DM8000Base (IBASE BT + Wi-Fi) • DM8700Base</p> |    |
|  | <p>Disable Alt Key Combo Zero Padding</p> <p>DM50 • DM70 • DM8000</p>                       |   |
|  | <p>Disable Alt Key Combo Zero Padding</p> <p>DM8000Base (IBASE BT + Wi-Fi) • DM8700Base</p> |  |





# USB Keyboard Inter-Character Delay

| Codes  | Settings and Supported Devices                          | Codes   |
|--|---|---|
|   | <p>*0 ms OFF</p> <p>DM50 • DM70 • DM8000</p>            |   |
|  | <p>100 ms ON</p> <p>DM50 • DM70 • DM8000</p>            |    |
|  | <p>*0 ms OFF</p> <p>DM8000Base (IBASE) • DM8700Base</p> |   |
|  | <p>100 ms ON</p> <p>DM8000Base (IBASE) • DM8700Base</p> |  |

# WebHMI Commands

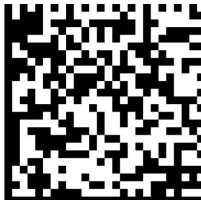
| Codes   | Settings and Supported Devices                          | Codes   |
|---|---|---|
|    | <p>Enable WebHMI</p> <p>DM370 • DM470</p>               |   |
|   | <p>Disable WebHMI</p> <p>DM370 • DM470</p>              |    |
|   | <p>Enable WebHMI Actions Menu</p> <p>DM370 • DM470</p>  |   |
|   | <p>Disable WebHMI Actions Menu</p> <p>DM370 • DM470</p> |  |
|  | <p>Enable WebHMI Settings Menu</p> <p>DM370 • DM470</p> |   |

| Codes   | Settings and Supported Devices                                  | Codes   |
|---|---|---|
|   | <p>Disable WebHMI Settings Menu</p> <p>DM370 • DM470</p>        |    |
|    | <p>Enable WebHMI Match String Menu</p> <p>DM370 • DM470</p>     |   |
|   | <p>Disable WebHMI Match String Menu</p> <p>DM370 • DM470</p>    |   |
|  | <p>Set WebHMI Language to German</p> <p>DM370 • DM470</p>       |   |
|   | <p>Set WebHMI Language to English (US)</p> <p>DM370 • DM470</p> |  |

| Codes   | Settings and Supported Devices                                     | Codes   |
|---|--|---|
|    | <p>Set WebHMI Language to Spanish</p> <p>DM370 • DM470</p>         |   |
|   | <p>Set WebHMI Language to French</p> <p>DM370 • DM470</p>          |    |
|   | <p>Set WebHMI Language to Japanese</p> <p>DM370 • DM470</p>        |   |
|   | <p>Set WebHMI Language to Korean</p> <p>DM370 • DM470</p>          |  |
|  | <p>Set WebHMI Language to Portuguese (BR)</p> <p>DM370 • DM470</p> |   |

| Codes | Settings and Supported Devices                      | Codes   |
|-------|---|---|
|       | Set WebHMI Language to Chinese<br><br>DM370 • DM470 |  |



